

TURBO 2 ULTRAFAST HIGH VOLTAGE RECTIFIER

Table 1: Main Product Characteristics

$I_{F(AV)}$	30 A
V_{RRM}	600 V
T_j	175°C
V_F (typ)	1.10 V
t_{rr} (max)	50 ns

FEATURES AND BENEFITS

- Ultrafast switching
- Low reverse current
- Low thermal resistance
- Reduces switching & conduction losses

DESCRIPTION

The STTH30R06, which is using ST Turbo 2 600V technology, is specially suited for use in switching power supplies, and industrial applications, as rectification and discontinuous mode PFC boost diode.

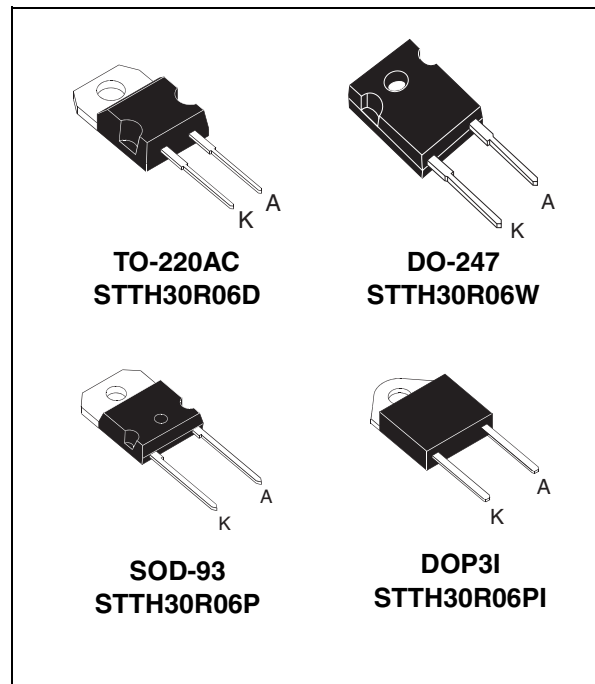

Table 2: Order Codes

Part Number	Marking
STTH30R06D	STTH30R06D
STTH30R06W	STTH30R06W
STTH30R06P	STTH30R06P
STTH30R06PI	STTH30R06PI

Table 3: Absolute Ratings (limiting values)

Symbol	Parameter		Value	Unit	
V_{RRM}	Repetitive peak reverse voltage		600	V	
$I_{F(RMS)}$	RMS forward current		50	A	
$I_{F(AV)}$	Average forward current	TO-220AC / DO-247 / SOD-93	$T_c = 115^\circ\text{C} \quad \delta = 0.5$	30	A
		DOP3I	$T_c = 85^\circ\text{C} \quad \delta = 0.5$		
I_{FSM}	Surge non repetitive forward current		$t_p = 10\text{ms}$ sinusoidal	160	A
T_{stg}	Storage temperature range		-65 to + 175	°C	
T_j	Maximum operating junction temperature		175	°C	

Table 4: Thermal Resistance

Symbol	Parameter	Value (max.)	Unit
$R_{th(j-c)}$	Junction to case	TO-220AC / DO-247/ SOD-93	1.1
		DOP3I	1.7

Table 5: Static Electrical Characteristics

Symbol	Parameter	Test conditions	Min.	Typ	Max.	Unit
I_R^*	Reverse leakage current	$T_j = 25^\circ\text{C}$			25	μA
		$T_j = 150^\circ\text{C}$			80	
V_F^{**}	Forward voltage drop	$T_j = 25^\circ\text{C}$	$I_F = 30\text{A}$		1.85	V
		$T_j = 150^\circ\text{C}$			1.10	

Pulse test: * $t_p = 5\text{ ms}$, $\delta < 2\%$

** $t_p = 380\ \mu\text{s}$, $\delta < 2\%$

To evaluate the conduction losses use the following equation: $P = 1.07 \times I_{F(AV)} + 0.011 I_F^2(\text{RMS})$

Table 6: Dynamic Characteristics

Symbol	Parameter	Test conditions	Min.	Typ	Max.	Unit	
t_{rr}	Reverse recovery time	$T_j = 25^\circ\text{C}$	$I_F = 0.5\text{A}$ $I_{rr} = 0.25\text{A}$ $I_R = 1\text{A}$			50	
						$I_F = 1\text{A}$ $di_F/dt = 50\text{ A}/\mu\text{s}$ $V_R = 30\text{V}$	50
I_{RM}	Reverse recovery current	$T_j = 125^\circ\text{C}$	$I_F = 30\text{A}$ $V_R = 400\text{V}$		8	11	A
t_{fr}	Forward recovery time	$T_j = 25^\circ\text{C}$	$I_F = 30\text{A}$ $di_F/dt = 100\text{ A}/\mu\text{s}$			500	ns
V_{FP}	Forward recovery voltage	$T_j = 25^\circ\text{C}$	$I_F = 30\text{A}$ $di_F/dt = 100\text{ A}/\mu\text{s}$		2.5		V

Figure 1: Conduction losses versus average forward current

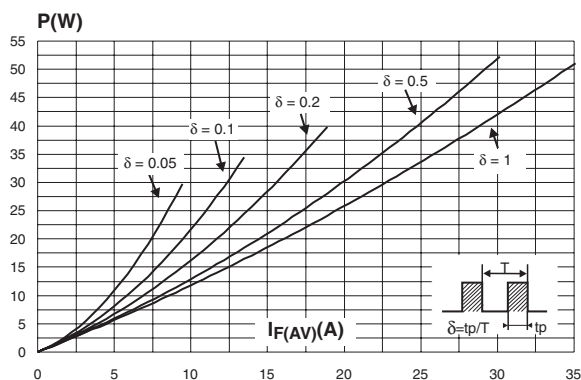

Figure 2: Forward voltage drop versus forward current

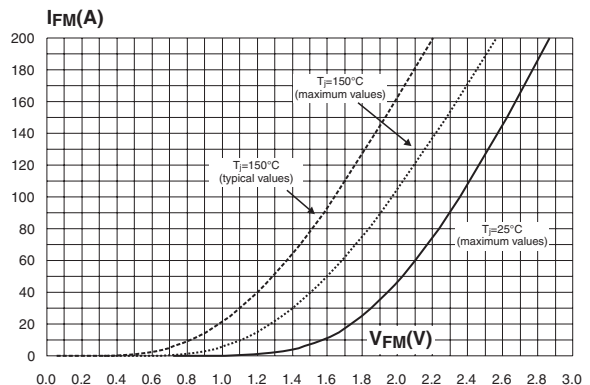

Figure 3: Relative variation of thermal impedance junction to case versus pulse duration

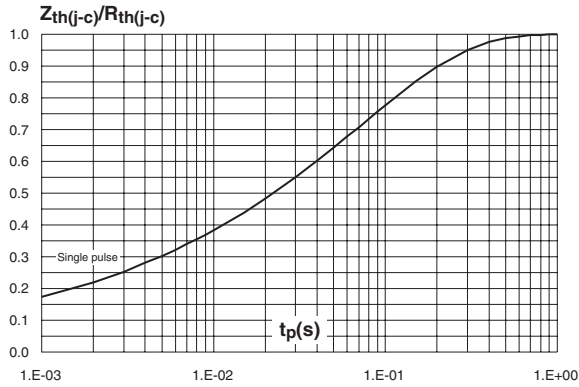

Figure 4: Peak reverse recovery current versus di_F/dt (typical values)

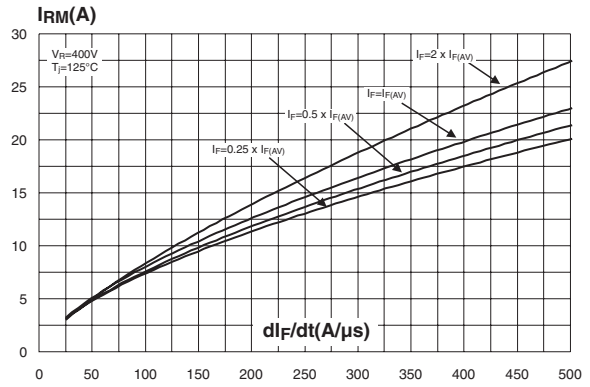

Figure 5: Reverse recovery time versus di_F/dt (typical values)

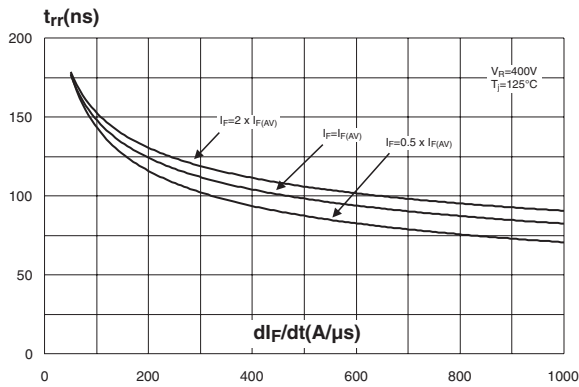

Figure 6: Reverse recovery charges versus di_F/dt (typical values)

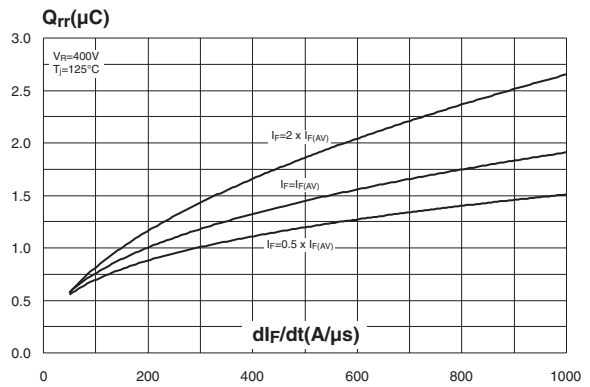

Figure 7: Softness factor versus di_F/dt (typical values)

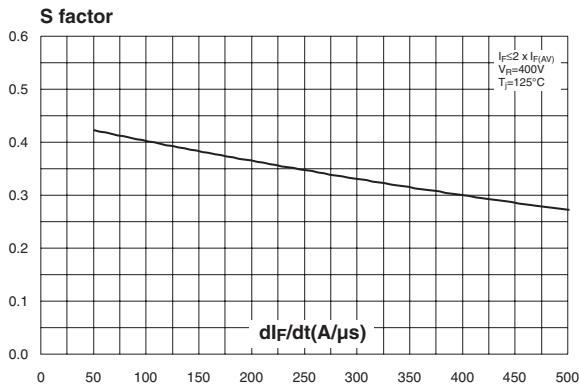

Figure 8: Relative variations of dynamic parameters versus junction temperature

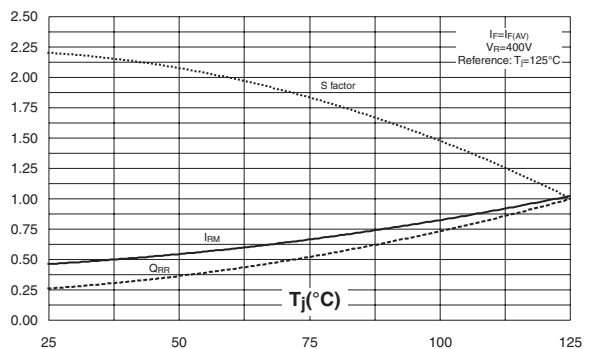

Figure 9: Transient peak forward voltage versus di_F/dt (typical values)

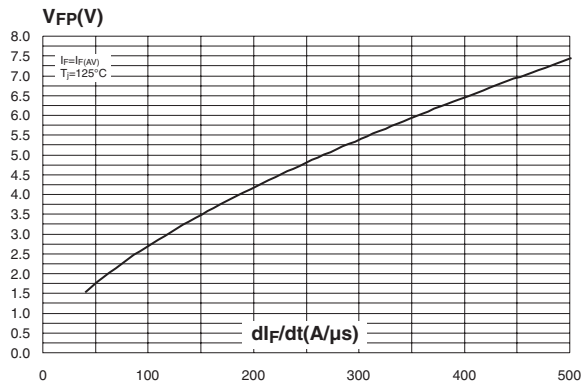

Figure 10: Forward recovery time versus di_F/dt (typical values)

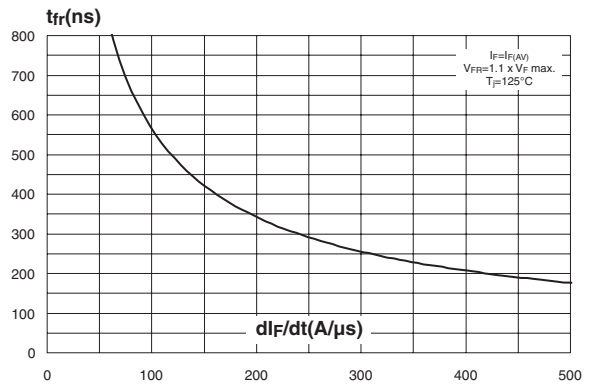

Figure 11: Junction capacitance versus reverse voltage applied (typical values)

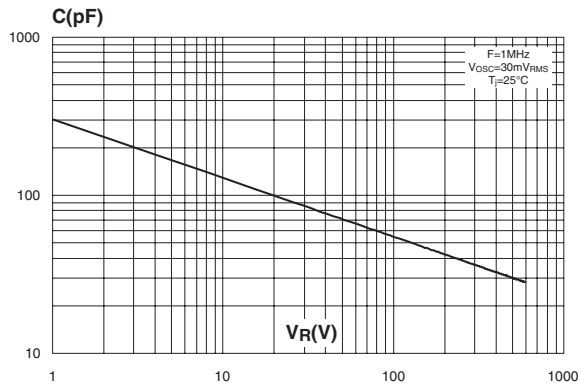

Figure 12: DO-247 Package Mechanical Data

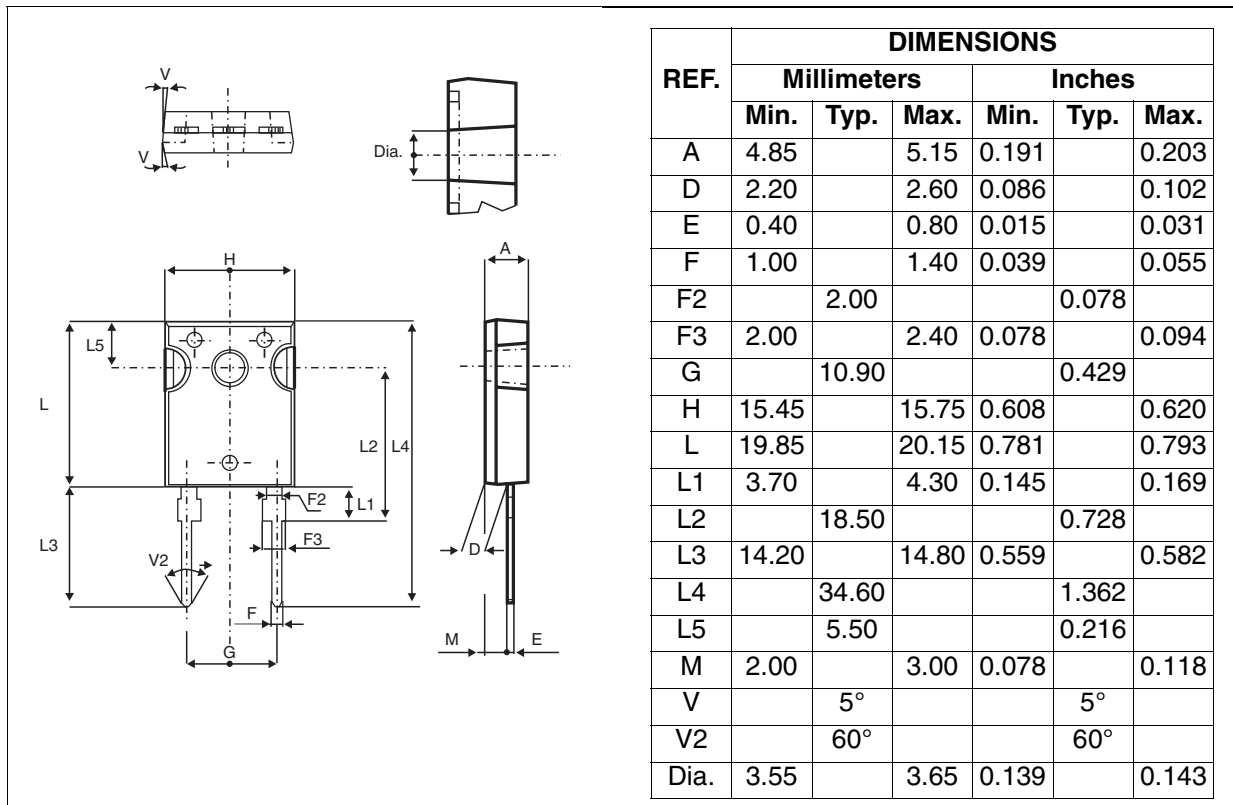

Figure 13: SOD-93 Package Mechanical Data

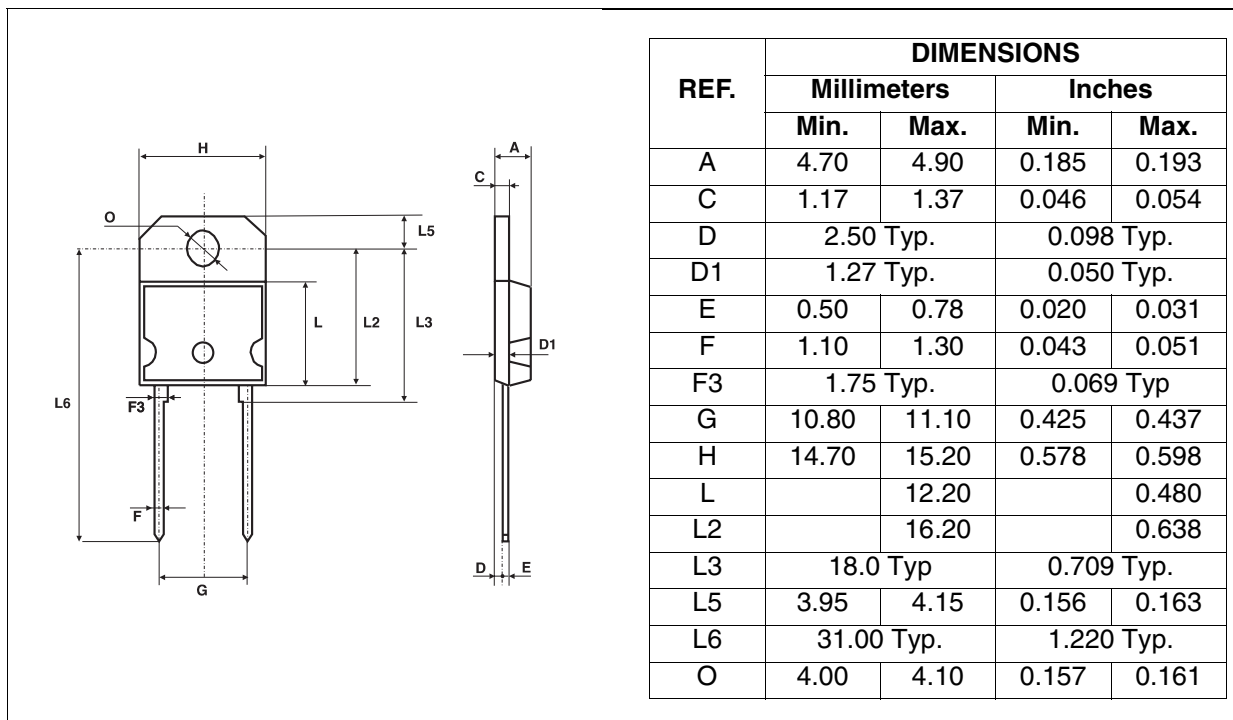

Figure 14: TO-220AC Package Mechanical Data

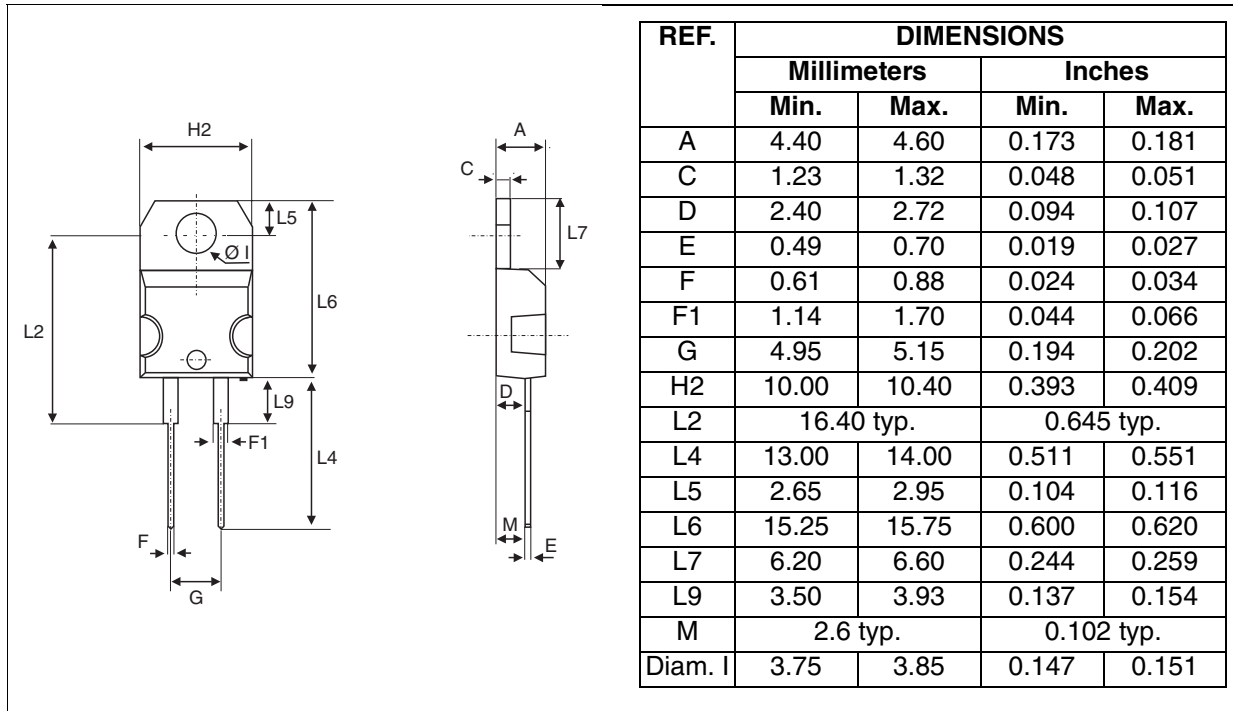

Figure 15: DOP3I Package Mechanical Data

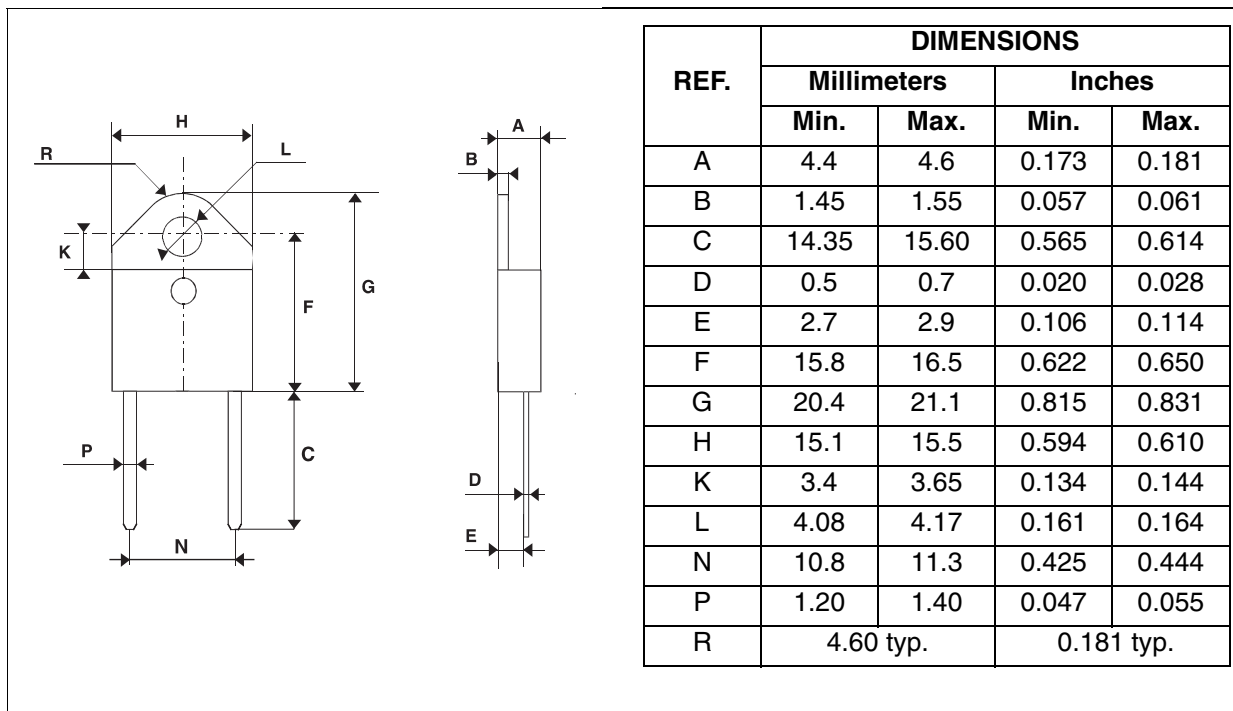

Table 7: Ordering Information

Ordering type	Marking	Package	Weight	Base qty	Delivery mode
STTH30R06D	STTH30R06D	TO-220AC	1.90 g	50	Tube
STTH30R06W	STTH30R06W	DO-247	4.40 g	30	Tube
STTH30R06P	STTH30R06P	SOD-93	3.79 g	30	Tube
STTH30R06PI	STTH30R06PI	DOP3I	4.46 g	30	Tube

- Epoxy meets UL94, V0
- Cooling method: by conduction (C)
- Recommended torque value: 0.55 m.N. (TO-220AC)
- Maximum torque value: 0.70 m.N. (TO-220AC)

Table 8: Revision History

Date	Revision	Description of Changes
18-Oct-2004	1	First issue

Information furnished is believed to be accurate and reliable. However, STMicroelectronics assumes no responsibility for the consequences of use of such information nor for any infringement of patents or other rights of third parties which may result from its use. No license is granted by implication or otherwise under any patent or patent rights of STMicroelectronics. Specifications mentioned in this publication are subject to change without notice. This publication supersedes and replaces all information previously supplied. STMicroelectronics products are not authorized for use as critical components in life support devices or systems without express written approval of STMicroelectronics.

The ST logo is a registered trademark of STMicroelectronics.
All other names are the property of their respective owners

© 2004 STMicroelectronics - All rights reserved

STMicroelectronics group of companies

Australia - Belgium - Brazil - Canada - China - Czech Republic - Finland - France - Germany - Hong Kong - India - Israel - Italy - Japan -
Malaysia - Malta - Morocco - Singapore - Spain - Sweden - Switzerland - United Kingdom - United States of America
www.st.com